

MOUSTIQUAIRE PLISSE – PS1 . PS1 V



Dimensions garanties

	LARGEUR MINIMALE (MM)	LARGEUR MAXIMALE (MM)	HAUTEUR MINIMALE (MM)	HAUTEUR MAXIMALE (MM)
PS1	700	2500	1750	2750
PS1 V*	700	2500	800	1700
			2800	3400

*délai non - standard

Profils

Profil bas 4mm

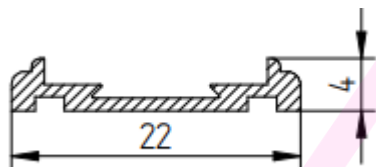

Canal amovible

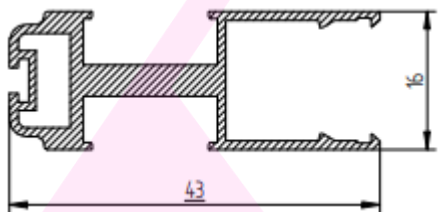

Profil sur cadre

Profilé latéral en aluminium de 40mm

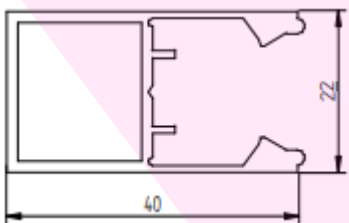

Profilé supérieur en aluminium de 40 mm

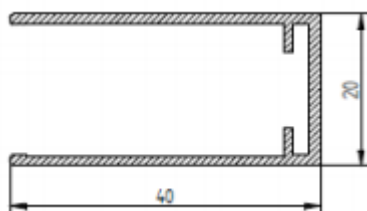

canal aimanté

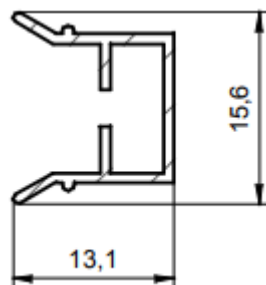

Profilé supérieur en aluminium de 40 mm

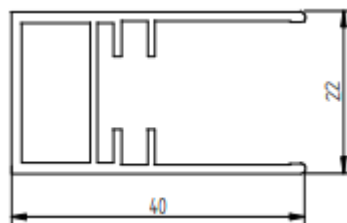

profilé latéral en aluminium de 25mm

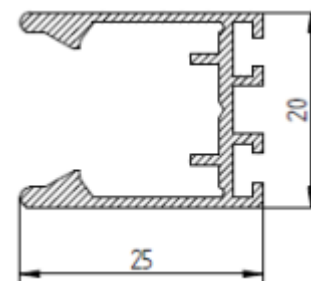

Section horizontale

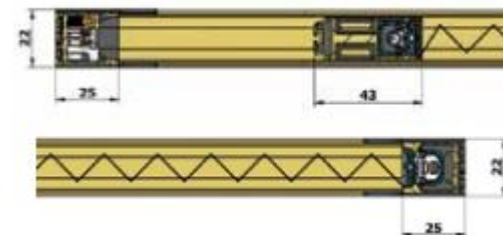

Section verticale

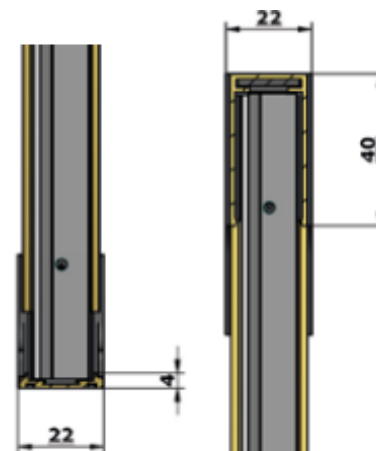

Couleurs

Standard couleurs du filet



Standard couleurs du cadre



Standard couleurs des pièces plastiques



Version de couleur standard PS1

FILET	CADRE	PIECES PLASTIQUES
gris noir	RAL 9010 blanc RAL 1013 ivoire RAL 8017 brun RAL 7016 anthracite RAL 6005 vert mat	blanc noir brun ivoire

Note: Autres couleurs RAL et DECORAL avec laquage

Version de couleur standard PS1 V

FILET	CADRE	PIECES PLASTIQUES
gris noir	RAL 9010 blanc RAL 1013 ivoire RAL 8017 brun RAL 7016 anthracite RAL 6005 vert mat	blanc noir brun ivoire

Note: couleur RAL 7035 avec laquage

Variante de montage

- dans la baie et sur le cadre de fenêtre